

Data Sheet



Article number: 03706010

Description: Fluro rod end BRF 10
with ball bearing

Measures

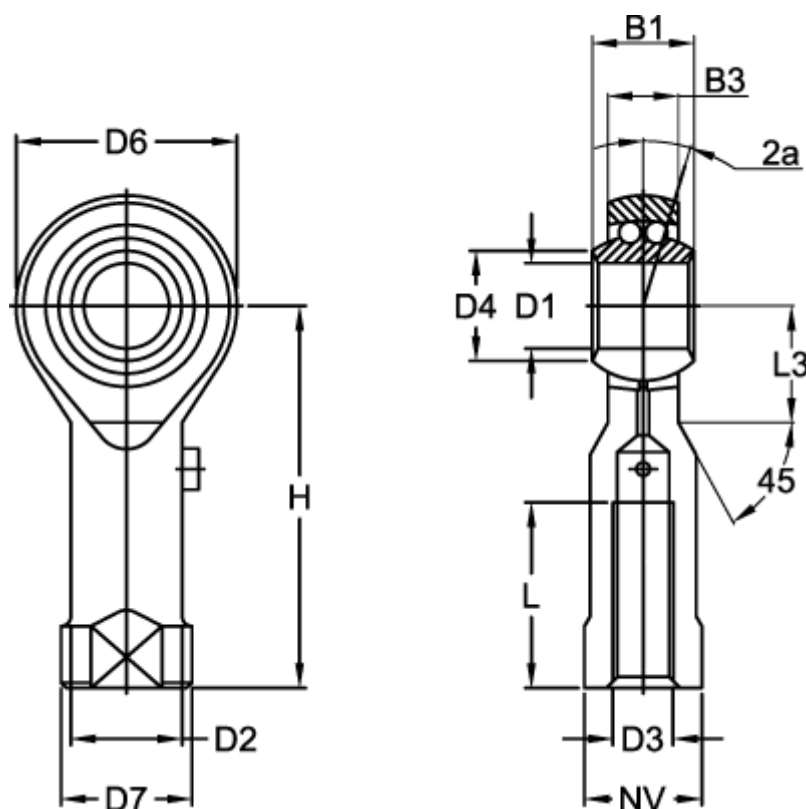

Angel 2a = 8.0	D7 = 19
B1 = 14	Dynamic load C (N) = 4450
B3 = 10.50	H = 43
D1 = 10	L = 20
D2 = 15.0	L3 = 15
D3 = M10x1,5	Max rpm = 1225
D4 = 12.0	NV = 17
D6 = 28	Static load (N) = 1450

Weight (kg) = 0.072